

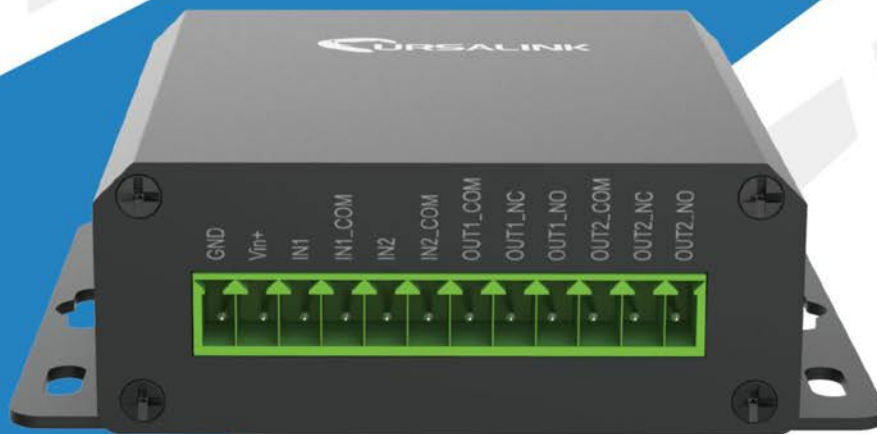

# Cellular&NB-IOT Remote I/O

## UC3x14 User Guide



# Contents

<b>1. Preface.....</b>	<b>3</b>
<b>2. Introduction.....</b>	<b>3</b>
2.1 Features.....	3
2.2 Parameters.....	4
2.3 LED Indicator Description.....	4
<b>3. Installation.....</b>	<b>5</b>
3.1 Environment.....	5
3.2 Power Supply.....	5
3.3 Micro USB Port.....	6
3.4 Terminal Description.....	6
3.5 Digital Input.....	6
3.6 Relay Output.....	7
<b>4. Configuration.....</b>	<b>9</b>
4.1 Configuration via PC.....	9
4.1.1 Serial Port Settings.....	10
4.2 Status.....	11
4.3 General.....	12
4.3.1 Send Data To the Ursalink Cloud.....	12
4.3.2 Send Data To the User-built Server on AWS.....	13
4.3.3 Send Data To the User-built Server by TCP.....	14
4.3.4 Send Data To the User-built Server by UDP.....	16
4.3.5 Send Data To the User-built Server by MQTT.....	17
4.3.6 Send Data To the User-built Server on Aliyun (Only Applicable to UC3514).....	20
4.3.7 Cellular Settings.....	21
4.4 Command.....	22
4.4.1 Read Command from Device.....	22
4.4.2 Open a Command File.....	23
4.4.3 Save the Command to Device.....	24
4.4.4 Save the Command as File.....	24
4.5 IF-THEN Behaviour Command.....	25
4.5.1 Supported IF Condition.....	25
4.5.2 Supported THEN Actions.....	27
4.6 Upgrade.....	28
<b>5. Application Examples.....</b>	<b>30</b>
5.1 Monitoring Alarm.....	30
5.2 Control Appliances.....	31
5.2.1 Remotely Control a Bulb on Ursalink Cloud.....	31
5.2.2 Send an Alert When Over-temperature Occurs.....	31
5.2.3 Turn on the Heater Regularly.....	32

# 1. Preface

Thank you for choosing Ursalink UC3x14 Cellular/NB-IoT Remote I/O. This user guide will present in detail all the functions and features of the product. UC3x14 is designed for both industrial and commercial applications. The product should be used under the guidance of this user guide, referring to parameters and technical specifications. The UC3x14 series is a compact, high-performance device that offers remote controllability and easy management of machines and equipment over the cellular/NB-IoT network.

We bear no liability for property loss or physically injury arising from abnormal or incorrect usage of this product.

# 2. Introduction

UR3x14 is designed as a cost-effective industrial machine monitoring device that monitors and controls up to 2 DC signals and 2 drivables.

With the aid of UC3x14, the alarm condition brings attention to engineering personnel immediately. Also, with Ursalink Cloud, the engineering personnel can trigger any relay outputs from anywhere at any time.

The device can give immediate response to the status of both input and output conditions. A cellular modem is embedded in UC3x14.

**(Model Naming Rule: UC3214 = 2G network version, UC3314 = 3G network version, UC3414 = 4G network version, UC3514 = NB-IoT network version)**

This user guide is intended to provide detailed technical specifications and explanations to basic users as well as technically-minded groups. It is a live document, and will be updated from time to time. Please ensure that you have the latest version, by checking our website at: <https://www.ursalink.com/en/documents-download/>

## 2.1 Features

- 2 digital inputs connected with up to 2 DC signals
- 2 relay drivable outputs
- Combined with data collection and transmission
- Easily configured by USB or Ursalink Cloud
- Ursalink Cloud for remote monitoring and control
- Support public cloud like AWS, Azure and Alibaba Cloud
- Support private UDP/TCP server
- Support MQTT protocol

- Operate autonomously even when cellular network is down
- Automatic switch of field devices at set times
- Customizable conditions & programmable actions
- Send alerts via email
- Reliable performance with built-in watchdog

## 2.2 Parameters

Parameter Item	Reference Scope
SIM Card	Micro SIM
Antenna	50 $\Omega$ SMA Antenna Interface
Digital Input	Opto-isolated depending on voltage Can accept any DC signals of any type, including: <ul style="list-style-type: none"> <li>➤ Dry Contacts</li> <li>➤ DC Voltage (3 - 20V)</li> </ul> High Voltage: +3V ~ +24V Low Voltage: +1V max
Digital Output	2 x SPDT Relay Contact Rating: 3Amp DC (Max: 30 V) or 3Amp AC (Max: 250 V)
IO Connector type	Screw Terminals
DC Power Supply	5-24 VDC
Power Consumption	Max: 1.6 W Average: 0.56 W
Operating Temperature	-40° C to +70° C (-40° F to +158° F) Reduce cellular performance above 60° C
Relative Humidity	0% to 95% (non- condensing)
Dimensions	79 x 60 x 24 mm

## 2.3 LED Indicator Description

### System:

- Solid On: Equipment starts
- On for 500ms, off for 500ms: All OK
- On for 100ms, off for 100ms: Device cannot connect to server

### ACT:

- Off: Network registration fails
- On for 75ms, off for 3000ms: Successfully registered on network
- On for 500ms, off for 500ms, blinking three times: Sending/Receiving MQTT message



## 3. Installation

### 3.1 Environment

Due to the product properties of UC3x14, we **STRONGLY** advise that it should not be installed in proximity to a variable speed drive or with any other electrically noisy equipment. **DO NOT** install UC3x14 into a metal enclosure unless an antenna is mounted on the outside of the enclosure.

### 3.2 Power Supply

UC3x14 features a 2 pin 3.5mm terminal block where a power supply can be connected. The power supply should have the following specifications:

- Output Voltage: 12V nominal
- Output Current: 0.5A

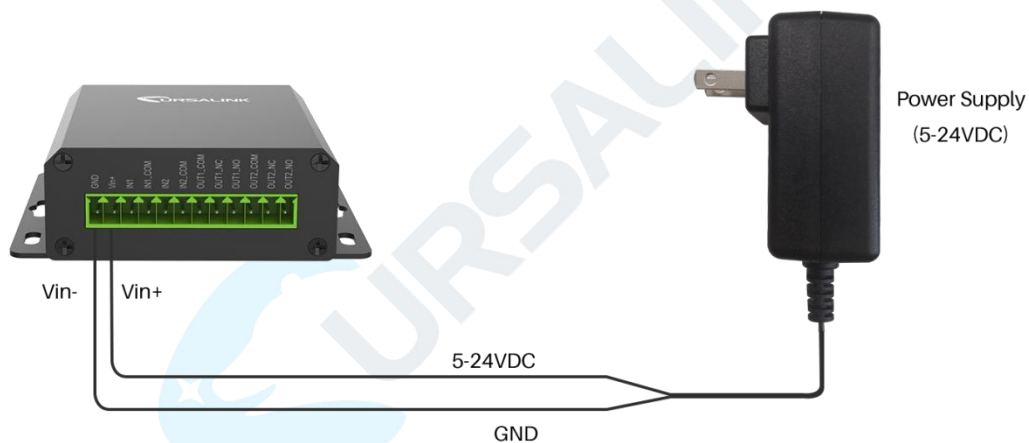

For industrial applications, it is advised that UC3x14 should be installed into its own metal housing and be powered from a separate power supply (as opposed to sharing one with other equipment).

Please Note: While UC3x14 has fairly rugged internal power supply circuitry, no special provision for lightning protection is well in place. If UC3x14 is used in an area where thunderstorm is about to occur, it is advisable to use a commercially available lightning suppressor (the same applies to inputs or outputs connected to wires longer than 2 or 3 meters). The guarantee does not cover damage resulting from lightning strikes! UC3x14 can operate reliably from voltages in the range of 5 to 24 VDC.

### 3.3 Micro USB Port

UC3x14 provides a micro USB port to connect to a PC via USB cable, which allows the PC to configure the unit.

### 3.4 Terminal Description

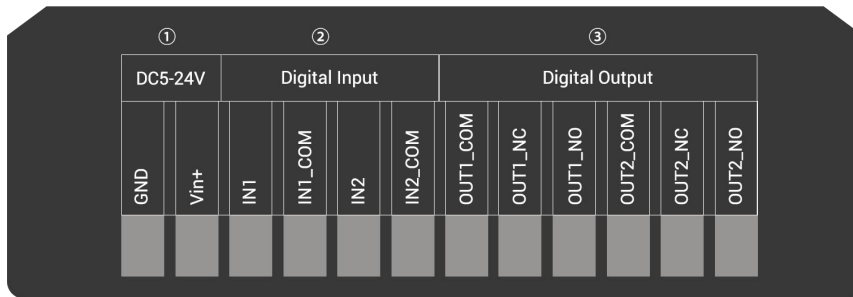

① [DC 5-24V]

Terminal	Description
Vin+	Positive terminal of the DC power supply (+)
GND	Negative terminal of the DC power supply (-)

② [Digital Input]

Opto-isolated depending on voltage DC Voltage (3-24V)

③ [Digital Output]

Driving relay to connect NC or NO

### 3.5 Digital Input

- When the input is triggered either as high or low, UC3x14 will take action if you have pre-configured related commands.
- Terminal "IN1" or "IN2" is internally pulled high. Leave the connection open or connect it to "0 -1 V", which will indicate an "Input-De-activate" state.
- When terminal "IN1" or "IN2" is connected to "3-24 V", it will indicate an "Input-Activate" state.
- Trigger voltage: Minimum = 3 VDC, Maximum = 24 VDC.

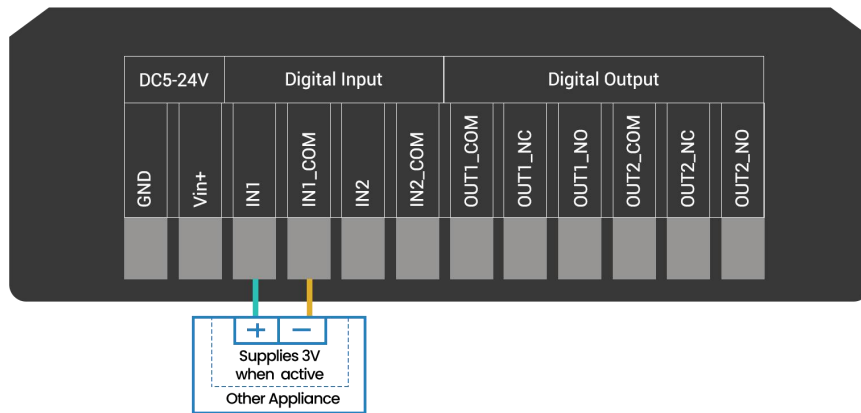

### 3.6 Relay Output

- The output is used to switch circuits on and off and can be controlled via Uرسالink Cloud.
- The output terminals are internally connected to a 3 Amp SPDT relay.
- OUT\_NC = Normally Closed
- OUT\_COM = Common
- OUT\_NO = Normally Open

Maximum Current	3 Amp
Maximum Voltage	250VAC, 30VDC

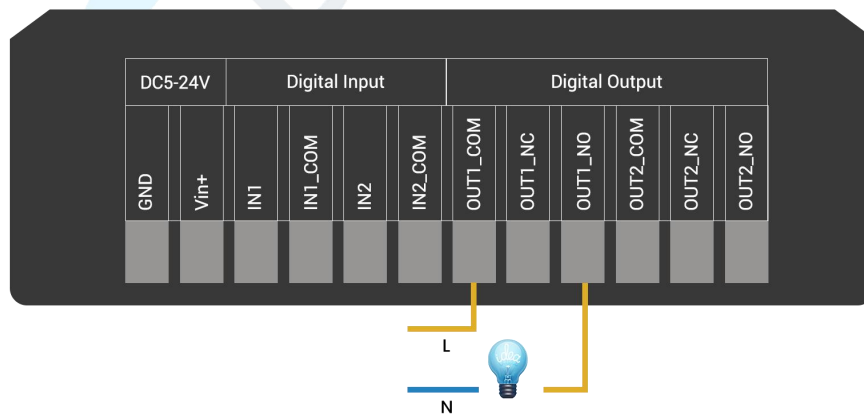

- When the output is off, the COM and N/C terminals will be internally connected to each other. Here is a schematic of the output circuit:

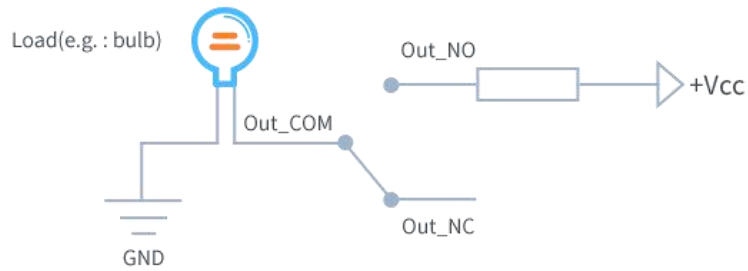

- When the output is on, the COM and N/O terminals will be internally connected to each other. Here is a schematic of the output circuit:

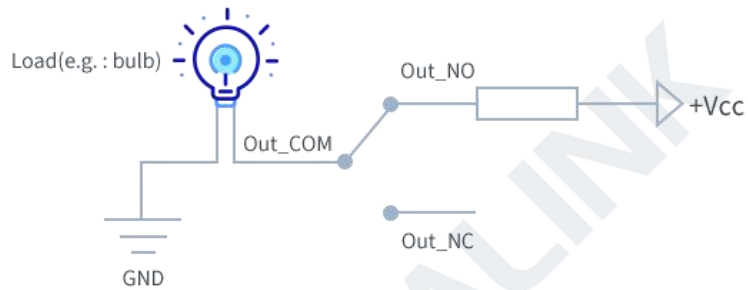

## 4. Configuration

### 4.1 Configuration via PC

Follow these steps:

Step 1: Insert SIM card into the unit.

Step 2: Connect UC3x14 to PC via the micro USB port.

Step 3: Power on UC3x14.

Step 4: Run the Ursalink ToolBox.

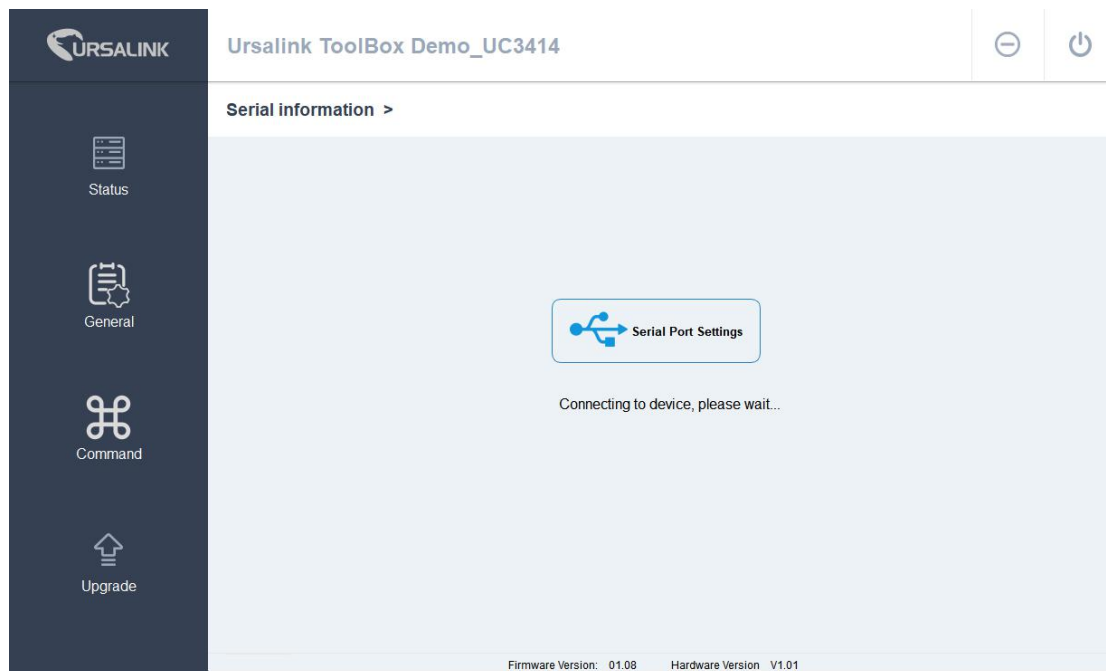

The software will display this interface when getting started. Here you can create a new setup, import an existing setup from your PC, or retrieve the current setup from the Ursalink UC3x14.

### 4.1.1 Serial Port Settings

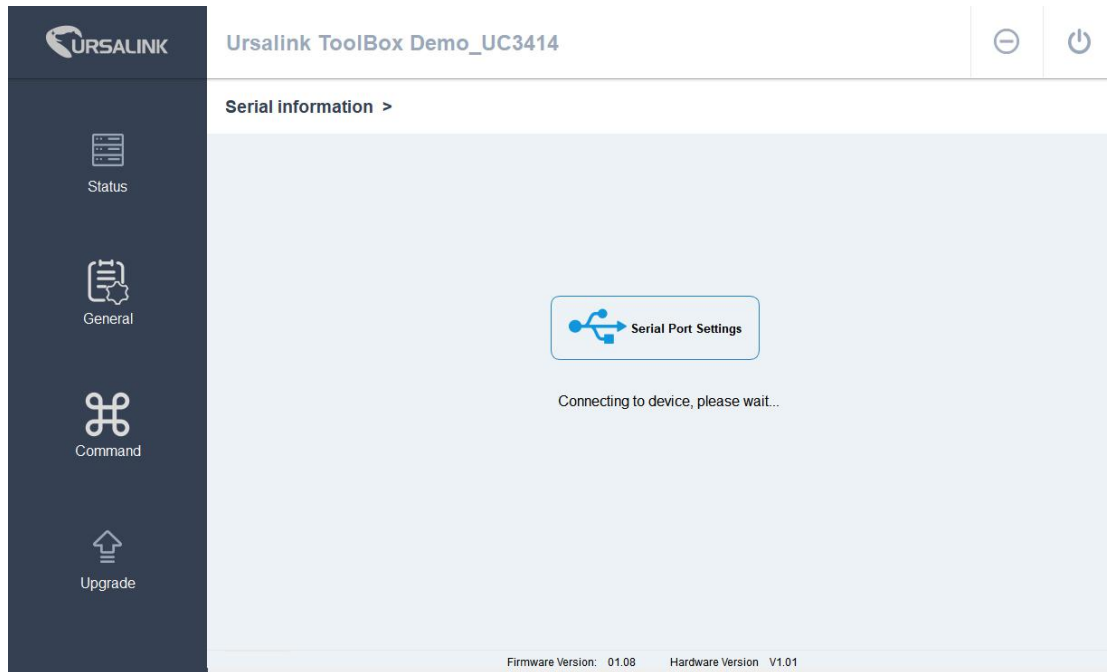

When the Ursalink ToolBox displays: **Connecting to device, please wait...**  
 You can click **Serial Port Settings** to set the correct serial port parameters.

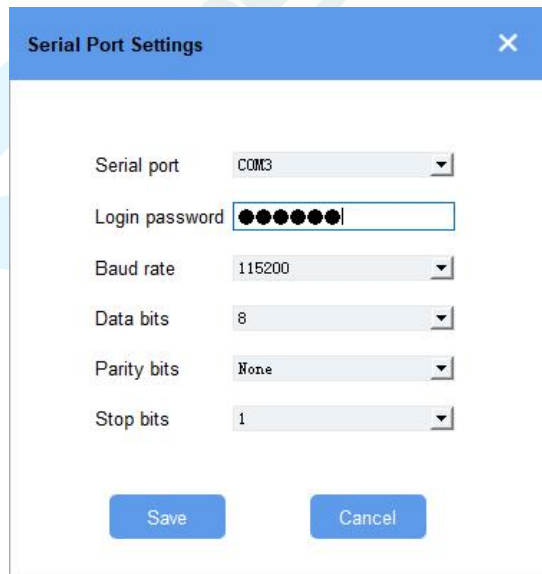

Serial Port Settings		
Item	Description	Default
Serial Port	Select the serial port for data transmission.	Null
Login Password	Enter the login password.	123456

Baud Rate	Select from "9600", "57600", "115200".	115200
Data Bits	Select from "5", "7", "8".	8
Parity Bits	Select from "Even", "Odd", "None".	None
Stop Bits	Select from "1", "2".	1

If both the serial port parameters and the login password are correct, it will display: Serial port is connected.



## 4.2 Status

Click "Status" to see the basic status information of this device:

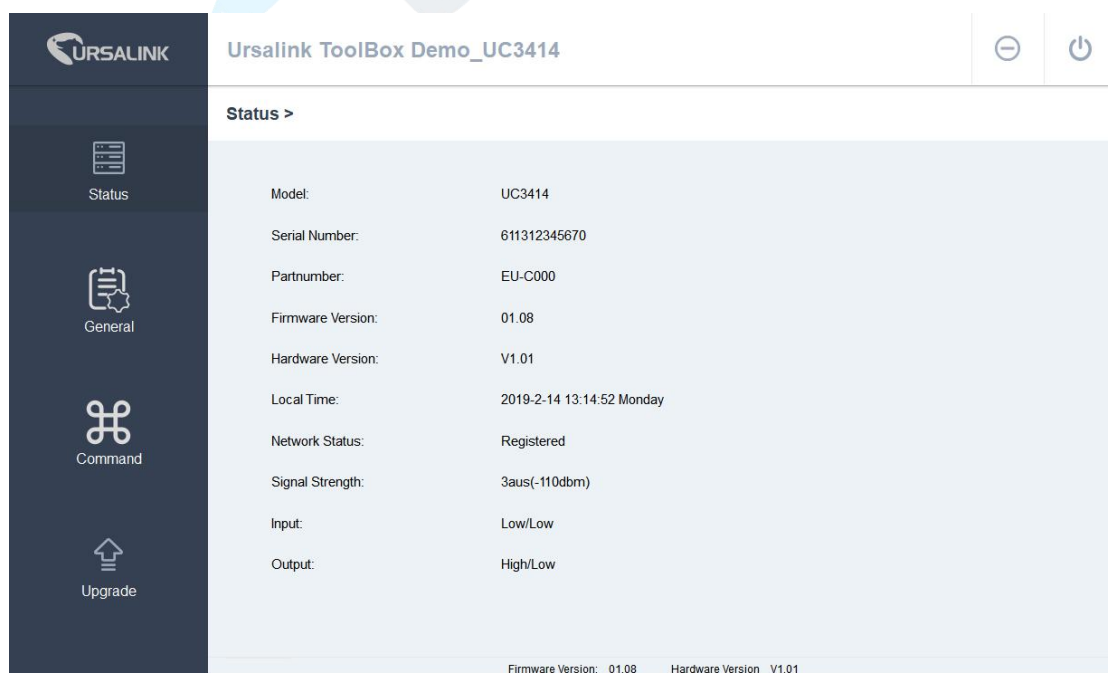

**URSALINK** Ursalink ToolBox Demo\_UC3414

**Status >**

- Model: UC3414
- Serial Number: 611312345670
- Partnumber: EU-C000
- Firmware Version: 01.08
- Hardware Version: V1.01
- Local Time: 2019-2-14 13:14:52 Monday
- Network Status: Registered
- Signal Strength: 3aus(-110dbm)
- Input: Low/Low
- Output: High/Low

Firmware Version: 01.08 Hardware Version V1.01

Status	
Item	Description
Local Time	Show the time of the device.
Network Status	Show the registration status of SIM card.
Signal Strength	Show the cellular signal strength.
Input	Show the status of Digital Input1/Input2.
Output	Show the status of Digital Output1/Output2.

## 4.3 General

Click "General" to set the general settings of this device:

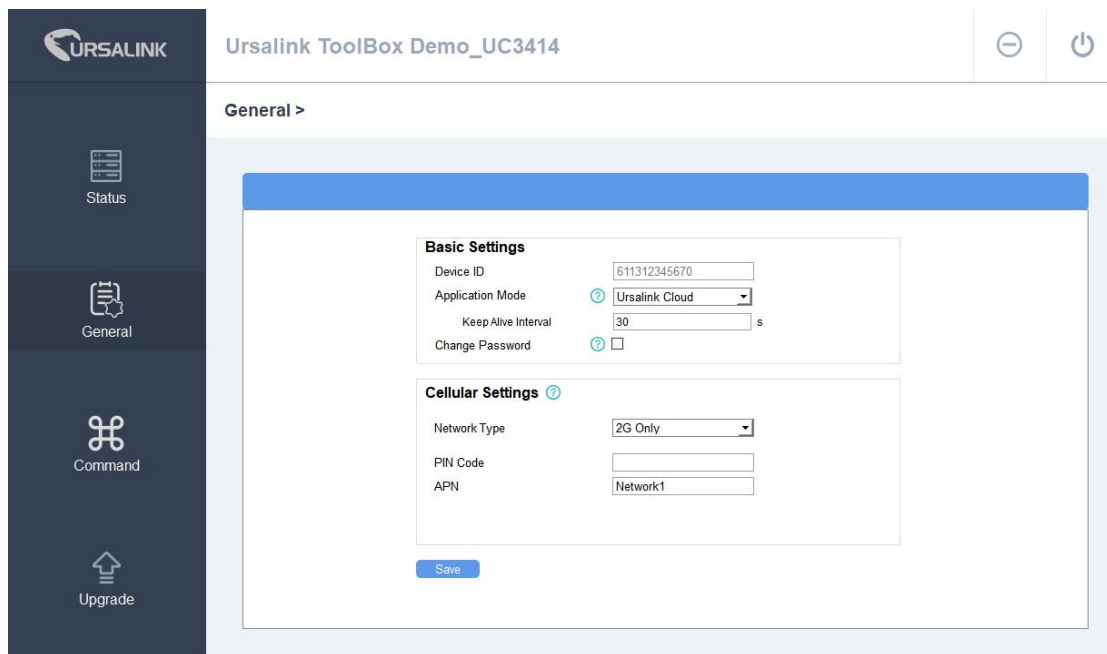

The screenshot shows the 'General' settings page in the Ursalink web interface. The page title is 'Ursalink ToolBox Demo\_UC3414'. The left sidebar contains icons for 'Status', 'General', 'Command', and 'Upgrade'. The main content area displays the following settings:

- Basic Settings**
  - Device ID: 611312345670
  - Application Mode: Ursalink Cloud
  - Keep Alive Interval: 30 s
  - Change Password:
- Cellular Settings**
  - Network Type: 2G Only
  - PIN Code:
  - APN: Network1

A 'Save' button is located at the bottom of the settings area.

### 4.3.1 Send Data To the Ursalink Cloud

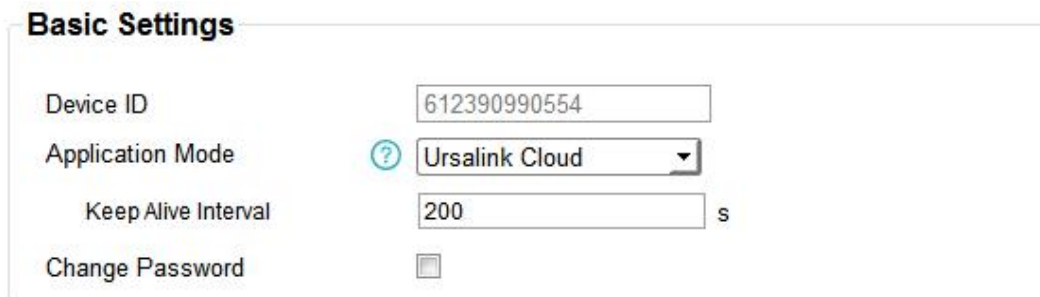

This close-up screenshot shows the 'Basic Settings' section with the following values:

- Device ID: 612390990554
- Application Mode: Ursalink Cloud
- Keep Alive Interval: 200 s
- Change Password:



Basic Settings_Ursalink Cloud		
Item	Description	Default
Device ID	Show the identifier of the device.	The SN of the device
Application Mode	Choose the control method from: Null, Ursalink Cloud, AWS, TCP, UDP, MQTT. Ursalink Cloud: The device will transmit data to Ursalink Cloud, and users can configure the device via Ursalink Cloud only.	Ursalink Cloud
Keep Alive Interval/s	After the device is connected with Ursalink Cloud, the device will send heartbeat packet to the Ursalink Cloud regularly by MQTT to keep alive. The interval range is 1-3600 seconds.	10

### 4.3.2 Send Data To the User-built Server on AWS

**Basic Settings**

Device ID

Application Mode ?

Server Address

Keep Alive Interval  s

Reporting Interval  s

Data Polling Interval  s

CAFile

Client Certificate File

Client Key File

Change Password

Basic Settings_AWS		
Item	Description	Default
Application Mode	AWS: The device will transmit data to the user-built server on AWS.	-
Server Address	Fill in the server address used for receiving data.	Null
Keep Alive Interval/s	After the device is connected with AWS, the device will send heartbeat packet to the AWS regularly by	10

	MQTT to keep alive. The interval range is 1-3600 seconds.	
Reporting Interval	Set the regular report interval. The device will send I/O status and signal strength to the user-built server regularly. The interval range is 1-86400 seconds.	300
Data Polling Interval	Set the Data Polling interval. The device will read I/O status and signal strength regularly. The interval range is 1-3600 seconds.	30
CA File	Upload the AWS IoT-generated CA certificate file for device authentication.	Null
Client Certificate File	Upload the AWS IoT-generated client certificate file for device authentication.	Null
Client Key File	Upload the AWS IoT-generated client key file for device authentication.	Null

### 4.3.3 Send Data To the User-built Server by TCP

#### Basic Settings

Device ID	<input type="text" value="612390990554"/>
Description	<input type="text" value="This is a UC for ..."/>
Application Mode	<input type="text" value="TCP"/>
Reporting Interval	<input type="text" value="60"/> s
Data Polling Interval	<input type="text" value="12"/> s
TCP Keep Alive Interval	<input type="text" value="1"/> min
Custom Heartbeat Mode	<input checked="" type="checkbox"/>
Custom Content	<input type="text"/>
Heartbeat Interval	<input type="text" value="30"/> s
Require Response	<input type="checkbox"/>
Response Content	<input type="text"/>

Server Address	Server Port	Status
<input type="text" value="110.87.98.58"/>	<input type="text" value="9007"/>	Disconnected
<input type="text" value="0.0.0.0"/>	<input type="text" value="0"/>	Disconnected

Basic Settings_TCP		
Item	Description	Default
Device ID	Show the identifier of the device.	The SN of the device
Description	Enter the description of the device. The device will send a message with the description to the server when first connected, which is typically used for identifying the device.	Null
Application Mode	TCP: The device will transmit data to the user-built server by TCP.	-
Reporting Interval	Set the regular report interval. The device will send the I/O status and signal strength to the user-built server regularly. The interval range is 1-86400 seconds.	300
Data Polling Interval	Set the Data Polling interval. The device will read the I/O status and signal strength regularly. The interval range is 1-3600 seconds.	30
TCP Keep Alive Interval/min	After TCP client is connected with TCP server, the device will send heartbeat packet to the server regularly by TCP to keep alive. The interval range is 1-120 minutes.	1
Custom Heartbeat Mode	The device will send custom heartbeat packet to the server when this function is enabled.	Disabled
Custom Content	Please enter the content of this packet when custom heartbeat mode is enabled.	Null
Heartbeat Interval/s	After TCP client is connected with TCP server, the device will also send custom heartbeat packet to the server regularly by TCP to keep alive. The interval range is 1-3600 seconds.	30
Require Response	If this function is enabled, the server will reply with a packet with specific content when it receives a custom heartbeat packet. <b>Note:</b> This mode can only be enabled when custom heartbeat mode is enabled.	Disabled
Response Content	Please enter the content of this response packet.	Null
Server Address	Fill in the TCP server address (IP/domain name).	Null
Server Port	Fill in the TCP server port. Range: 1-65535.	Null
Status	Show the connection status between the server and the device.	Null

### 4.3.4 Send Data To the User-built Server by UDP

**Basic Settings**

Device ID

Description

Application Mode

Reporting Interval  s

Data Polling Interval  s

Custom Heartbeat Mode

Custom Content

Heartbeat Interval  s

Require Response

Response Content

Server Address	Server Port	Status
<input type="text" value="110.87.98.58"/>	<input type="text" value="9007"/>	Disconnected
<input type="text" value="0.0.0.0"/>	<input type="text" value="0"/>	Disconnected

Change Password

Basic Settings_UDP		
Item	Description	Default
Device ID	Show the identifier of the device.	The SN of the device
Description	Enter the description of the device. The device will send a message with the description to the server when first connected, which is typically used for identifying the device.	Null
Application Mode	UDP: The device will transmit data to the user-built server by UDP.	--
Reporting Interval	Set the regular report interval. The device will send I/O status and signal strength to the user-built server regularly. The interval range is 1-86400 seconds.	300
Data Polling Interval	Set the Data Polling interval. The device will read the I/O status and signal strength regularly.	30

	The interval range is 1-3600 seconds.	
Custom Heartbeat Mode	The device will send custom heartbeat packet to the server when this function is enabled.	Disabled
Custom Content	Please enter the content of this packet when custom heartbeat mode is enabled.	Null
Heartbeat Interval/s	After UDP client is connected with UDP server, the device will also send custom heartbeat packet to the server regularly by UDP to keep alive. The interval range is 1-3600 seconds.	30
Require Response	If this function is enabled, the server will reply with a packet with specific content when it receives a custom heartbeat packet. <b>Note:</b> This mode can only be enabled when custom heartbeat mode is enabled.	Disabled
Response Content	Please enter the content of this response packet.	Null
Server Address	Fill in the UDP server address (IP/domain name).	Null
Server Port	Fill in the UDP server port. Range: 1-65535.	Null
Status	Show the connection status between the server and the device. <b>Note:</b> The connection status can only be displayed when require response mode is enabled.	Null

### 4.3.5 Send Data To the User-built Server by MQTT

#### Basic Settings

Device ID	<input type="text" value="612390990554"/>
Description	<input type="text" value="This is a UC for ..."/>
Application Mode	<input type="text" value="MQTT"/>
Reporting Interval	<input type="text" value="60"/> s
Data Polling Interval	<input type="text" value="30"/> s
Broker Address	<input type="text"/>
Port	<input type="text" value="9004"/>
Client ID	<input type="text" value="MQTT_FX"/>
Connection Timeout	<input type="text" value="30"/> s
Keep Alive Interval	<input type="text" value="60"/> s
Change Password	<input type="checkbox"/>

Basic Settings_MQTT		
Item	Description	Default
Device ID	Show the identifier of the device.	The SN of the device
Description	Enter the description of the device. The device will send a message with the description to the server when first connected, which is typically used for identifying the device.	Null
Application Mode	MQTT: The device will transmit data to the user-built server by MQTT.	--
Reporting Interval	Set the regular report interval. The device will send I/O status/value and signal strength to the Server regularly. The interval range is 1-86400 seconds.	300
Data Polling Interval	Set the data polling interval. The device will read the I/O status/value and signal strength regularly. The interval range is 1-3600 seconds.	30
Broker Address	Fill in the broker address for receiving data.	--
Broker Port	Fill in the broker port for receiving data.	--
Client ID	Client ID is the unique identity of the client to the server. It must be unique when all clients are connected to the same server, and is the key to handling message at QoS 1 and 2.	--
Connection Timeout	Set the maximum time that the client waits for the response from the server. If the client does not get a response after the maximum response time, it's determined that the connection has broken. The range is 1-9999 seconds.	30
Keep Alive Retry Times	After MQTT client is connected with the MQTT broker, the device will send heartbeat packet to the broker regularly by MQTT to keep alive. The interval range is 1-9999 seconds.	60
Change Password	Change the password of the connected device.	--

Select the authentication method required by the server.

When you select user credentials for authentication, you need to enter the username and password required for authentication.

### User Credentials

Enable	<input checked="" type="checkbox"/>
Username	<input type="text" value="admin"/>
Password	<input type="password" value="••••••••"/>

If the server needs a certificate for verification:

Please import CA certificate, client certificate and client key file for authentication.

### TLS

Enable	<input checked="" type="checkbox"/>
Protocol	<input type="text" value="TLSv1.2"/>
CA File	<input type="text" value="ca"/> <a href="#">Browse</a> <a href="#">Import</a> <a href="#">Delete</a>
Client Certificate	<input type="text" value="client"/> <a href="#">Browse</a> <a href="#">Import</a> <a href="#">Delete</a>
Client Key	<input type="text" value="key"/> <a href="#">Browse</a> <a href="#">Import</a> <a href="#">Delete</a>



### 4.3.6 Send Data To the User-built Server on Aliyun (Only Applicable to UC3514)

**Basic Settings**

Device ID

Description

Application Mode ?  ▾

Reporting Interval  s

Data Polling Interval  s

Client ID

Product Key

Device Secret

Keep Alive Interval  s

QoS  ▾

Change Password ?

Basic Settings_Aliyun (Only Applicable to UC3514)		
Item	Description	Default
Device ID	Show the identifier of the device.	The SN of the device
Description	Enter the description of the device. The device will send a message with the description to the server when first connected, which is typically used for identifying the device.	Null
Application Mode	Aliyun: The device will transmit data to the user-built server on Aliyun.	--
Reporting Interval	Set the regular report interval. The device will send I/O status and signal strength to the Server regularly. The interval range is 1-86400 seconds.	1800
Data Polling Interval	Set the data polling interval. The device will read I/O status and signal strength regularly. The interval range is 1-3600 seconds.	360



Client ID	Client ID is the unique identity of the client to the server. It must be unique when all clients are connected to the same server, and is the key to handling message at QoS 1 and 2.	--
Product Key	Enter the product key for authentication. The unique key generated by Aliyun for this device.	--
Device Secret	Enter the device secret for authentication. The unique secret generated by Aliyun and should be used with the serial number in pairs.	--
Keep Alive Interval	After connected to Aliyun, the device will send heartbeat packet to the Aliyun regularly by TCP to keep alive. The interval range is 1-3600 seconds.	60
QoS	QoS 0—At Most Once: Message is sent only once and no steps to acknowledge delivery. This is the fastest and the most unreliable transfer mode.  QoS 1—At Least Once: This level guarantees that the message will be delivered at least once, but may be delivered more than once.  QoS 2—Exactly Once: This level guarantees that each message is received only once by the intended recipients. This is the safest and slowest quality of service level.	0
Change Password	Change the password of the connected device.	--

### 4.3.7 Cellular Settings

**Cellular Settings** ?

Network Type

PIN Code

APN

Cellular Settings (Only Applicable to UC3214/UC3314/UC3414)		
Item	Description	Default
Network Type	Choose the types of cellular network for Internet access priority. When you change the network type, you need to restart the device to make the change take effect.	Depending on the cellular module
PIN Code	Please enter a PIN code for locking your SIM card. The length is 4 - 8.	Null
APN	Enter the Access Point Name for cellular dial-up connection provided by local ISP. The length is 1 - 16.	Null

## 4.4 Command

### 4.4.1 Read Command from Device

Click "Command" to go to the configuration page. Ursalink ToolBox will read command from the connected device automatically. This will take about 5 seconds.

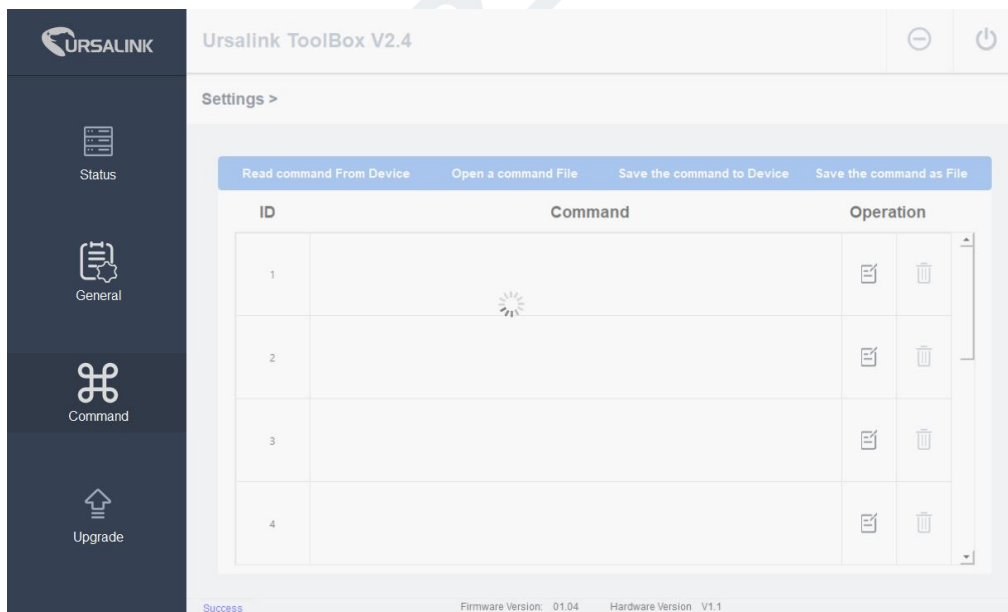

Then the command saved in this device will be displayed:

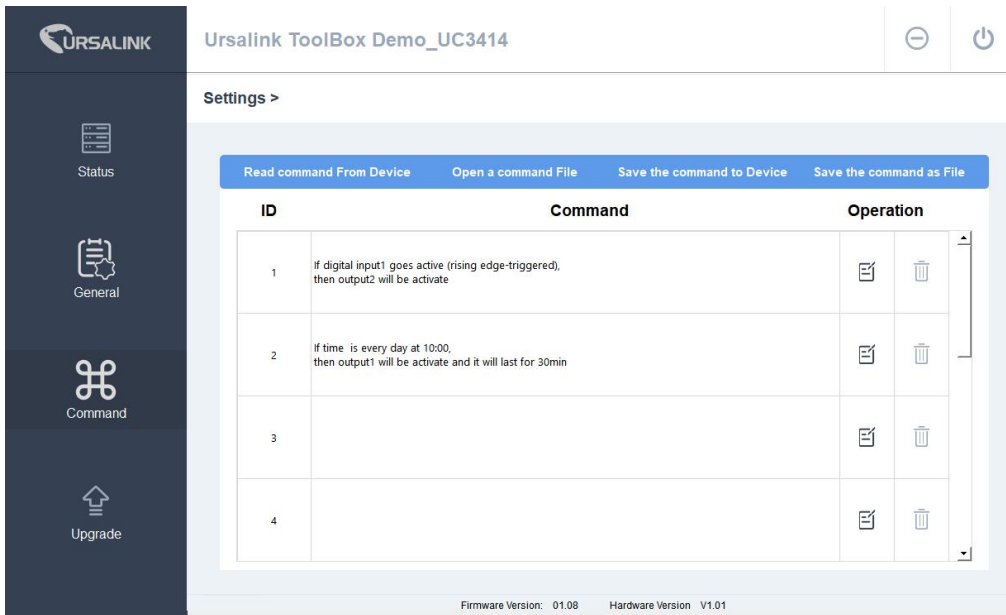

### 4.4.2 Open a Command File

You can import the existing command file from your PC as follows:

Step 1: Click "Open a Command File".

Step 2: Select the command file.

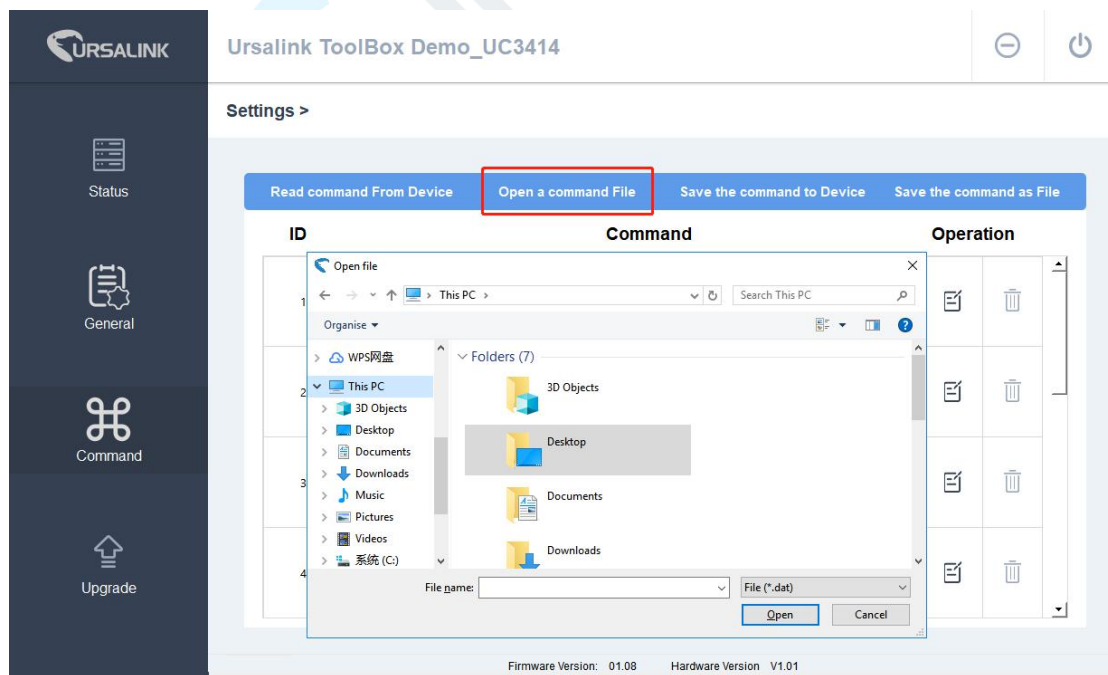

### 4.4.3 Save the Command to Device

You can click "Save the Command to Device" to save the command having been configured on the Ursalink ToolBox.

### 4.4.4 Save the Command as File

You can click "Save the Command as File" to save the command having been configured on the Ursalink ToolBox as a file and save it on your computer.

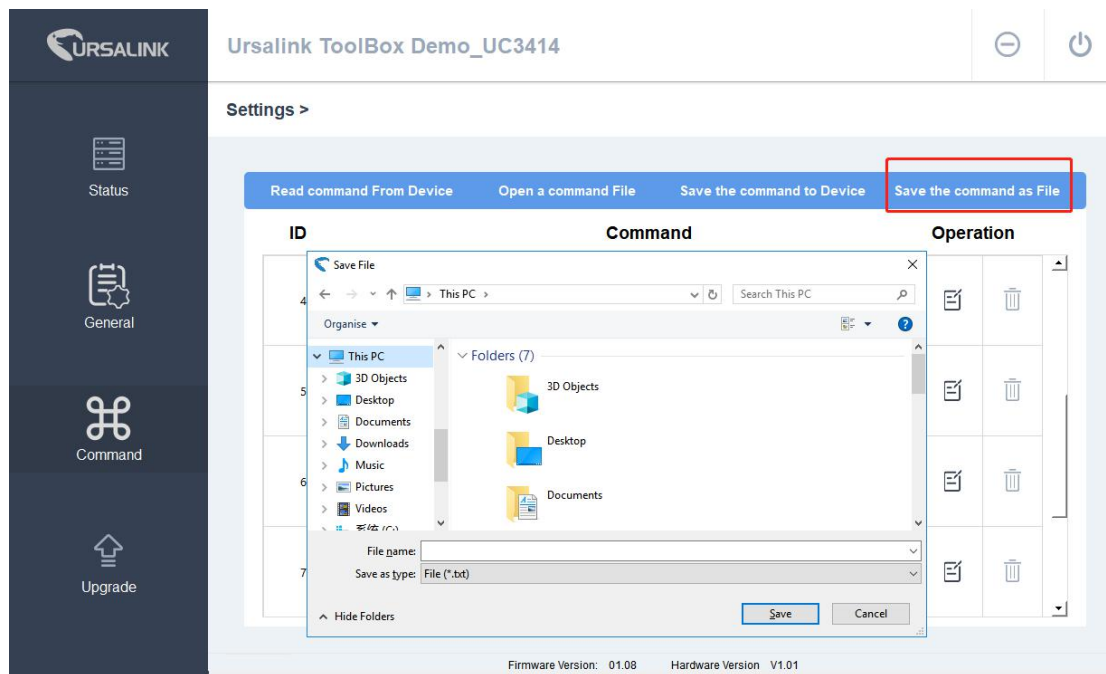

You can re-edit the file name and determine the storage path, the command will be saved as two types of files.

Name	Date modified	Type	Size
Command.dat	11/6/2018 4:11 PM	DAT File	4 KB
Command.txt	11/6/2018 4:11 PM	Text Document	2 KB

The ".dat" file can be recognized by Ursalink ToolBox only.

The ".txt" file is an editable text file for user.

## 4.5 IF-THEN Behaviour Command

The Ursalink UC3x14 is running with a number of defined behaviour commands. Each command takes the form of an IF-THEN statement pair. You are thus able to select certain trigger conditions to cause desired actions. The Ursalink UC3x14 allows up to 8 separate behaviour commands with some models.

Users can select time or input constraints for any IF-THEN statement pairs, so that an action will only be triggered during certain period within a day, or only if certain input/output conditions are met.

The user can enter the edit page by clicking  , or delete the command by clicking .

### 4.5.1 Supported IF Condition

#### 4.5.1.1 IF the Time Is ...

A command containing this IF condition will be triggered at a specific time every day within a specified range of dates, or on every selected day of the week.

IF

The user can choose the day of the week from:

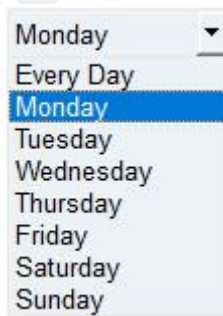

The user can also set the time from 00:00 to 23:59 on a certain day.

#### 4.5.1.2 IF Input

A command containing this IF condition will be triggered if the selected input changed according to the specified option.

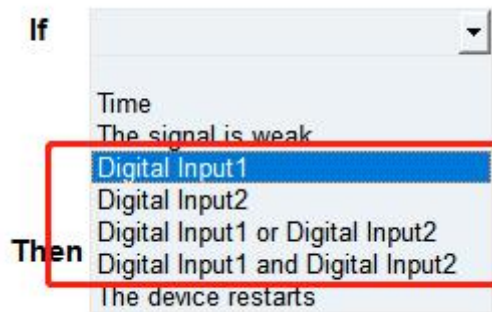

The user can setup multiple combinations; however, input 1 and input 2 must be activated before action is taken.

The logic options available include:

- AND: ALL the selected signals become active or ANY selected signals become inactive
- OR: ANY selected signals become active or ALL selected signals become inactive

Then the user can choose from the following options:

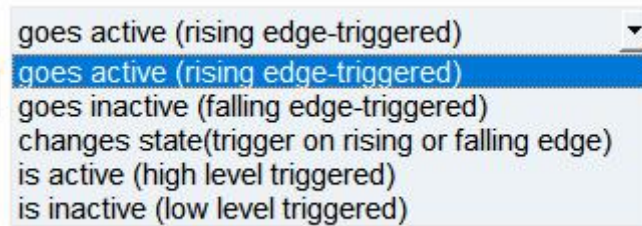

- Goes active (rising edge-triggered)
- Goes inactive (falling edge-triggered)
- Change status (triggered on rising or falling edge)
- Is active (high level triggered)
- Is inactive (low level triggered)

Thus, if the user chooses "Goes Active", then as soon as the specified input changes from inactive to active, the command will be triggered. Also, it applies to the remaining options when the preset conditions are met.

The user is also able to specify a "Continued time" for this command, which will not be triggered until it remains Active or Inactive longer than the time specified. Moreover, the user can specify a "Lockout time" for this command. After the command has been triggered, it will not be allowed to be triggered again until the time specified has elapsed.

When you set the time, you can choose the time unit:

Msec: 0-86400000

sec: 0-86400

min: 0-1440

Only integers are allowed. You can't use the decimal point.

**Note:** There are 3 single actions at most to be executed for a single trigger condition.

### 4.5.1.3 IF Signal Is Weak

A command containing this IF condition will be triggered once the signal strength meets the specified requirements: the value of asu is 1-10.

IF The signal is weak ▾

### 4.5.1.4 IF the Device Restarts

A command containing this IF condition will be triggered once the device has finished restarting.

IF If the device restarts ▾

## 4.5.2 Supported THEN Actions

### 4.5.2.1 THEN Change Output

A command containing this action will change the selected output according to specified actions.

Then Output2 ▾

Delay Time 6 s ▾

will be activate ▾

will be activate

will be de-activate

will follow the input to change

+

The user can choose from the following actions:

- Will be activated
- Will be deactivated
- Will follow the input: When the triggering condition is the input changes state, you can then select change state as the action.

IF Input1 ▾ changes state(trigger on rising or falling edge) ▾

is continued for 0 s ▾

Set lockout time 0

Then Output1 ▾ will follow the input to change ▾ +

If the user has configured:

- "Delay Time", the selected output will be activated after the specified time.
- "Duration", the output will remain current status for a certain period of time.

### 4.5.2.2 THEN Restart the Device

A command containing this action will restart the Ursalink UC3x14 if the condition is met.

Then Restart the device

### 4.5.2.3 THEN Send an Alarm

A command containing this action will send an alarm message to server if the condition is met.

Then Send an alarm

## 4.6 Upgrade

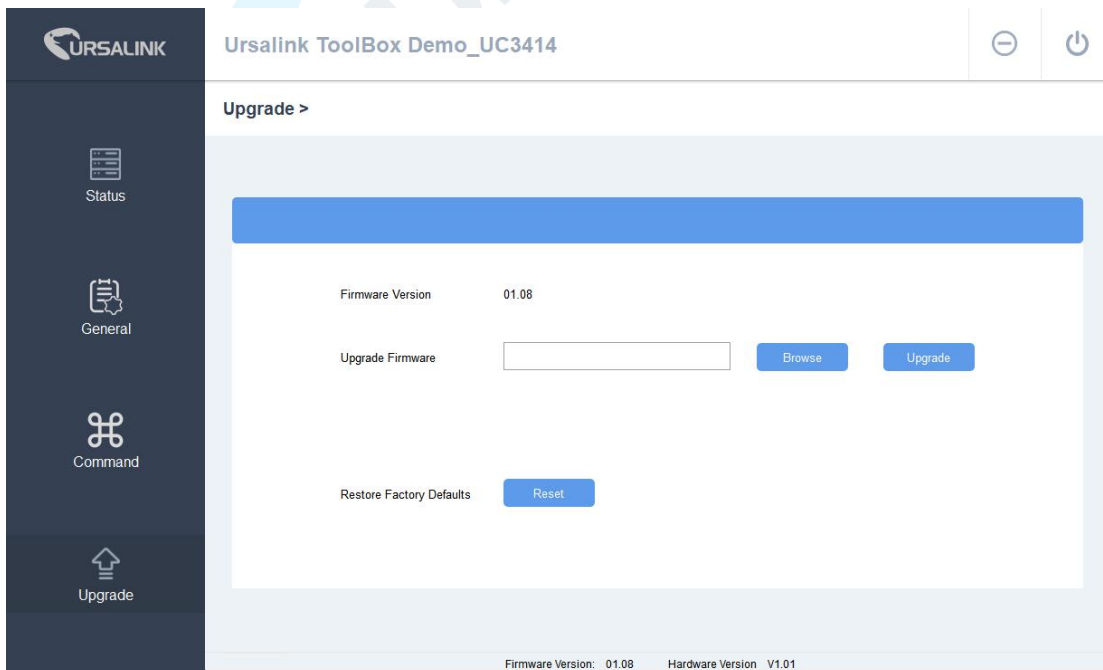

The screenshot shows the URSALINK Upgrade interface. The top bar displays the URSALINK logo and the title "Ursalink ToolBox Demo\_UC3414". The main content area is titled "Upgrade >". It features a blue header bar and a white content area with the following elements:

- Firmware Version:** 01.08
- Upgrade Firmware:** A text input field, a "Browse" button, and an "Upgrade" button.
- Restore Factory Defaults:** A "Reset" button.

The bottom status bar shows "Firmware Version: 01.08" and "Hardware Version: V1.01". The left sidebar contains navigation icons for Status, General, Command, and Upgrade.



Step 1: Connect UC3x14 to PC via the micro USB port.

Step 2: Power on UC3x14.

Step 3: Run the Ursalink ToolBox and go to "Upgrade".

Step 4: Click "Browse" and select the correct firmware file from the PC.

Step 5: Click "Upgrade" and the device will check if the firmware file is correct. If it's correct, the firmware will be imported to the device, and the device will restart after upgrading is completed.

**Note:** Any operation on Ursalink ToolBox is not allowed during upgrading, otherwise the upgrading will be interrupted, or even the device will break down.

Click "Reset", and the device will restore to the factory default settings.



## 5. Application Examples

### 5.1 Monitoring Alarm

In this case we need to monitor an alarm sensor, such as a manhole covers sensor or a water pressure sensor, UC3x14 will send out a message when any alarm occurs.

**Hardware:**

We connect the alarm output (12V signal that drives the siren) to one of the device's inputs. The positive wire from the alarm panel is connected to the IN1 terminal, and the negative wire is connected to IN1\_COM.

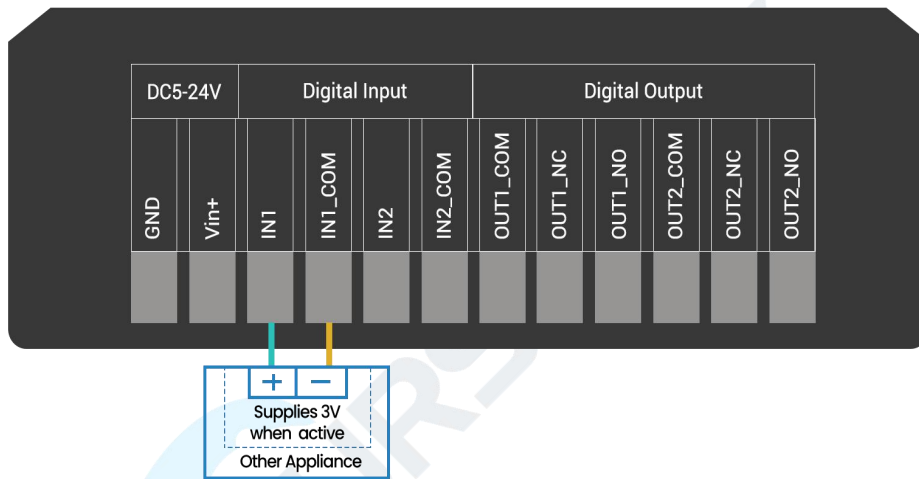

**Configuration:**

Configuration via Ursalink Cloud:

**IF**

is continued for  ms

Set lockout time

**Then**

## 5.2 Control Appliances

### 5.2.1 Remotely Control a Bulb on Ursalink Cloud

In this case we need to turn on or off a 220 V light bulb on Ursalink Cloud.

**Hardware:**

We connect a light bulb to a 220V power source via the output 1 contact on UC3x14.

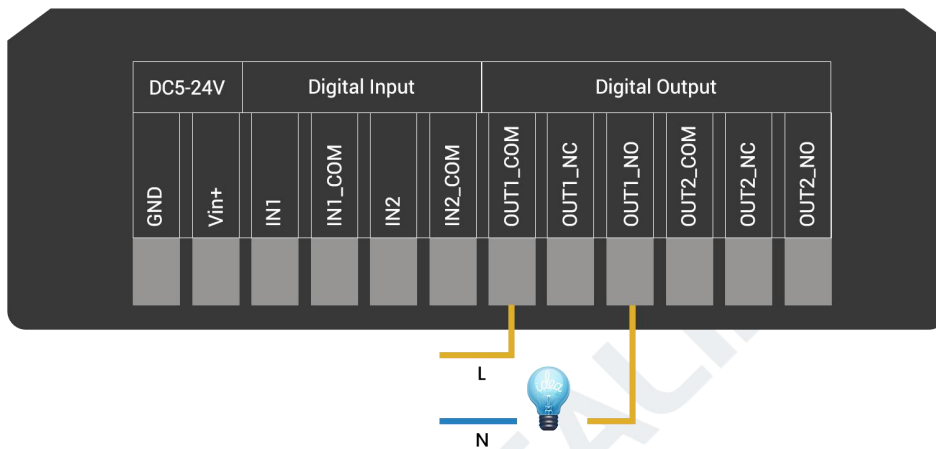

**Operation:**



### 5.2.2 Send an Alert When Over-temperature Occurs

**Configuration:**

**Hardware:**

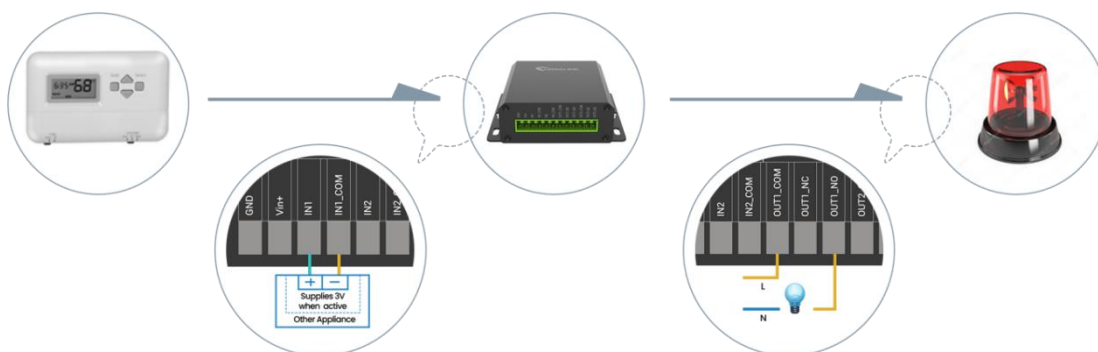

Configuration on Ursalink Cloud or Toolbox:

**IF**

is continued for

Set lockout time

**Then**

Delay

Duration

### 5.2.3 Turn on the Heater Regularly

Configuration:

Hardware:

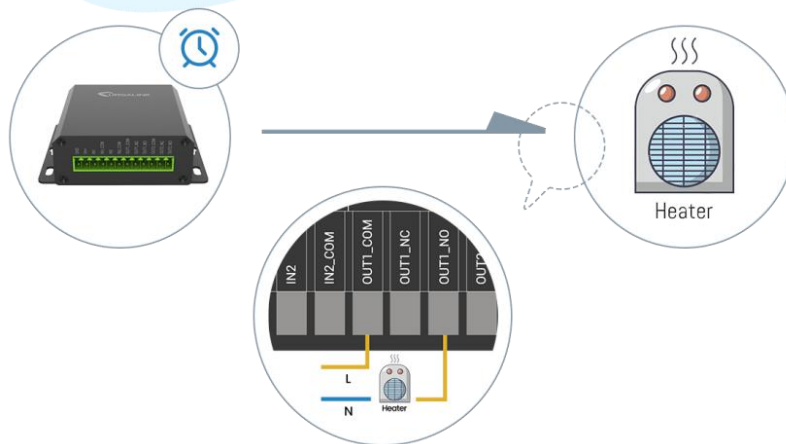

Configuration on Ursalink Cloud or Toolbox:

**IF**    :

The action you have set will be triggered at 09:00 Every Day (based on the time zone you have set)

**Then**

Delay

Duration

**-END-**

